

T783 - 200 Dining Table Assembly Instructions

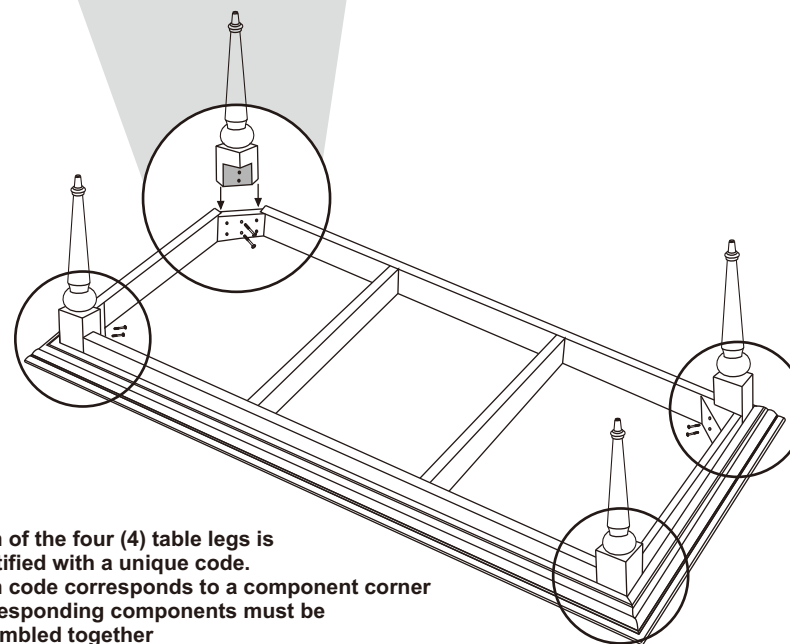
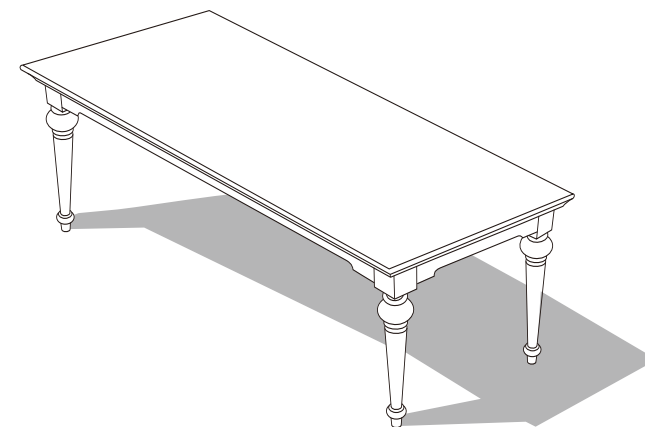
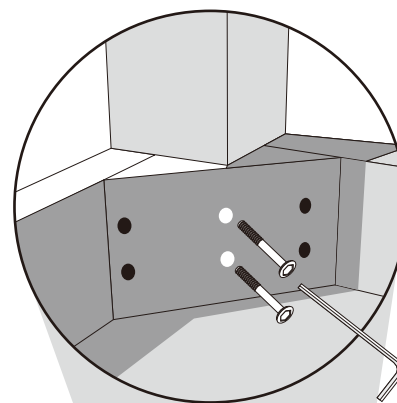
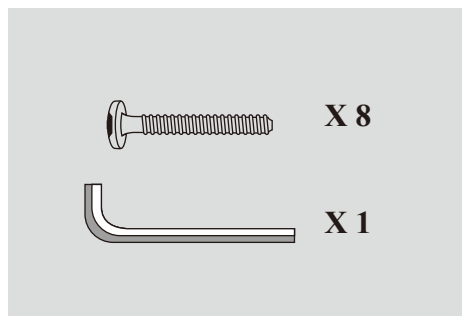
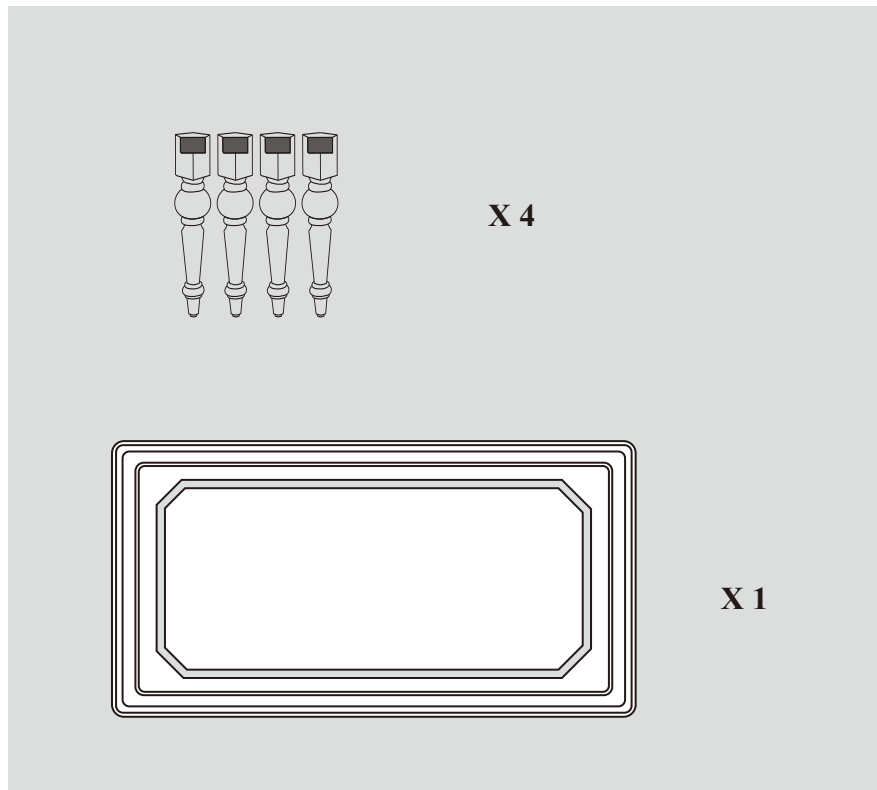
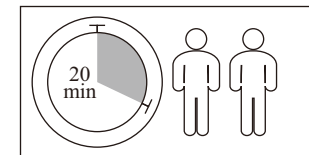

* Each of the four (4) table legs is identified with a unique code. Each code corresponds to a component corner. Corresponding components must be assembled together.

WARNING

Do not use this product before installing hardware as instructed. During assembly tighten screws by hand. Once all screws are in place use the tool to tighten until secure.